



# Python<sup>®</sup>

## Pneumatically Operated Pumps for Chemical Injection



PROVEN QUALITY. LEADING TECHNOLOGY.

# Python® Pneumatically Operated Pumps

Python pumps are ideal for applications that require a pump to operate in a potentially explosive atmosphere and can run off regulated natural gas or compressed air. These pumps have the lowest out of pocket cost, are easy to operate and use half the air consumption of other pumps in the market. Plus, the Python's extreme duty plungers, seals and timing valve are designed for years of operation before replacement.

## Ease of serviceability

- Easy access to the pump plunger and packings
- Cartridge style seal in the timing valve for quick and easy repair
- Plunger packings can be replaced in 5 minutes or less

## Highest technology timing valve on the market

- Low air/gas consumption for increased efficiency
- Pump cycle rate remains constant regardless of system back pressure

## Robust and simple design

- Adjustable fluid packing lasts up to 25 times longer than non-adjustable seals
- Pythons are offered with Chromex and Ceramic coated plungers
- 316 SST fluid section/wetted parts
- HNBR, FKM, FKM ETP, TFEP and FFKM plunger packings and check valve seals
- Proprietary poppet style check valve eliminates valve from sticking

## Standards



## Ordering Information

GRACO Python™ Pneumatically Operated Pumps							
Seals / Plunger Size	1/8"	3/16"	1/4"	3/8"	1/2"	5/8"	3/4"
<b>1.25" Air Piston (CE Approved)</b>							
FKM	A25000	A25001	A25002	A25003	A25004	A25005	A25006
FKM-ETP	A25021	A25022	A25023	A25024	A25025	A25026	A25027
HNBR	A25042	A25043	A25044	A25045	A25046	A25047	A25048
FFKM	A25063	A25064	A25065	A25066	A25067	A25068	A25069
<b>1.75" Air Piston (CE Approved)</b>							
FKM	A25007	A25008	A25009	A25010	A25011	A25012	A25013
FKM-ETP	A25028	A25029	A25030	A25031	A25032	A25033	A25034
HNBR	A25049	A25050	A25051	A25052	A25053	A25054	A25055
FFKM	A25070	A25071	A25072	A25073	A25074	A25075	A25076
<b>2" Air Piston (CE Approved)</b>							
FKM	A25014	A25015	A25016	A25017	A25018	A25019	A25020
FKM-ETP	A25035	A25036	A25037	A25038	A25039	A25040	A25041
HNBR	A25056	A25057	A25058	A25059	A25060	A25061	A25062
FFKM	A25077	A25078	A25079	A25080	A25081	A25082	A25083
<b>1.25" Air Piston (ATEX Approved)</b>							
FKM	A25100	A25101	A25102	A25103	A25104	A25105	A25106
FKM-ETP	A25121	A25122	A25123	A25124	A25125	A25126	A25127
HNBR	A25142	A25143	A25144	A25145	A25146	A25147	A25148
FFKM	A25163	A25164	A25165	A25166	A25167	A25168	A25169
<b>1.75" Air Piston (ATEX Approved)</b>							
FKM	A25107	A25108	A25109	A25110	A25111	A25112	A25113
FKM-ETP	A25128	A25129	A25130	A25131	A25132	A25133	A25134
HNBR	A25149	A25150	A25151	A25152	A25153	A25154	A25155
FFKM	A25170	A25171	A25172	A25173	A25174	A25175	A25176
<b>2" Air Piston (ATEX Approved)</b>							
FKM	A25114	A25115	A25116	A25117	A25118	A25119	A25120
FKM-ETP	A25135	A25136	A25137	A25138	A25139	A25140	A25141
HNBR	A25156	A25157	A25158	A25159	A25160	A25161	A25162
FFKM	A25177	A25178	A25179	A25180	A25181	A25182	A25183



ATEX Approved Python Pump

# Technical Data

Python Chemical Injection Pump		
	US	Metric
Maximum air inlet pressure	see charts on back page	
Maximum fluid working pressure	see charts on back page	
Environmental temperature range	-40°– 176°F	-40°– 80°C
<b>Noise (dBA)</b>		
Maximum sound pressure	<70 dBA with included muffler installed	
<b>Inlet/Outlet Sizes</b>		
Fluid inlet size	1/4 in. npt(f) (1/4 npt(m) adapter included)	
Fluid outlet size (1/4", 3/8", 1/2", 5/8", & 3/4" plungers only)	1/4 in. npt(f)	
Fluid outlet size (1/8" & 3/16" plungers only)	HiP HF4	
Prime/bleed size (1/4", 3/8", 1/2", 5/8", & 3/4" plungers only)	10-32 UNF	
Prime/bleed size (1/8" & 3/16" plungers only)	1/16 in. npt(f)	
Pneumatic inlet size	1/8 in. npt(f) (1/4 npt(f) adapter included)	
Pneumatic outlet size (exhaust recovery)	1/8 in. npt(f)	
<b>Materials of Construction</b>		
Pump/Check Valve Seal Material	See Configuration Number Matrix below for seal material.	
Wetted Parts	See Configuration Number Matrix below for plunger material. All other materials are 316 stainless steel unless otherwise noted.	
<b>Weight</b>		
All models	8-11 lbs.	3.6-4.9 kg

## Dimensions:

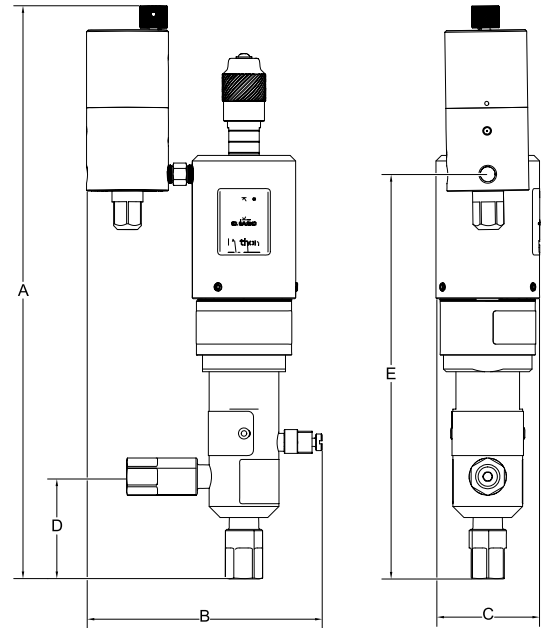

A	B	C	D	E
13.26 in. (33.7 cm)	5.3 in. (13.5 cm)	2.34 in. (5.9 cm)	2.3 in. (5.8 cm)	9.125 in. (23.2 cm)

# Configuration Number Matrix

Check the identification plate (ID) for the 12-digit Configuration Number of your pump. Use the following matrix to define the components of your pump. *NOTE: Not all combinations are possible.*

Sample Configuration Number: **PCI-125-19S-XA-A**

PCI	125	19	S	X	A	A
Pneumatic Chemical Injection	Air Motor Size	Plunger Size	Pressure Range	Plunger Material	Seal Material	Qualifier

Air Motor Size		Plunger Size (diameter)		Pressure Range		Plunger Material		Seal Material		Qualifier	
125	1-1/4"	13	1/4"	S	Standard Pressure (1/4", 3/8", 1/2", 5/8", 3/4" plungers)	X	Chromex Coated 17-4 PH Stainless	A	FKM	A	ATEX
175	1-3/4"	19	3/8"	H	High Pressure (1/8" & 3/16" plungers)	C	Ceramic Coated 17-4 PH Stainless	B	FKMETP		
200	2"	25	1/2"					C	HNBR		
		38	5/8"					D	FFKM		
		50	3/4"								
		63	5/8"								
		75	3/4"								

## Key Points

- Standard pressure pumps feature 1/4 in. NPT(F) inlet and outlet connections.
- High pressure pumps feature 1/4 in. NPT(F) inlet and HiP HF4 outlet connections.
- B32240 can be used to convert HF4 outlet connection to 1/4 in. NPT(F) for applications 10,000 psi and under.

# Performance Curves

## 1 1/4" Air Motors (PCI-125)

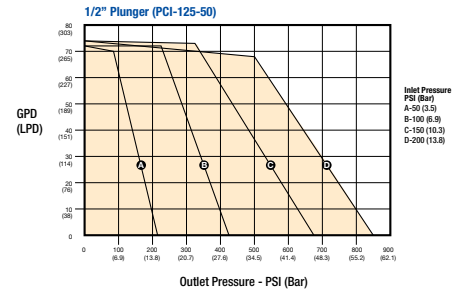
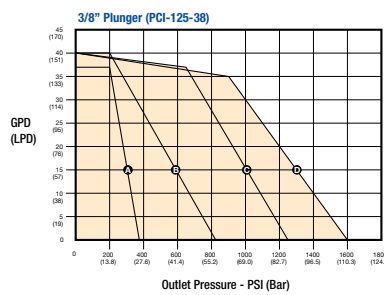
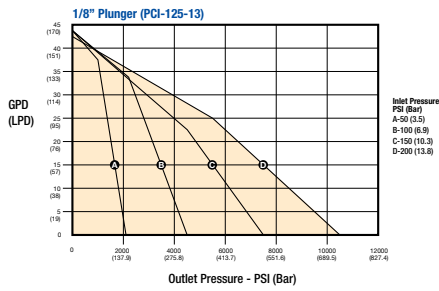

## 1 3/4" Air Motors (PCI-175)

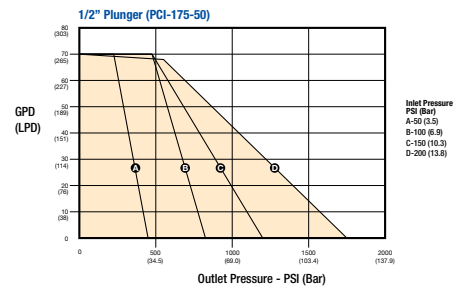
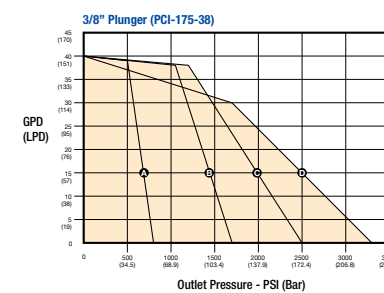
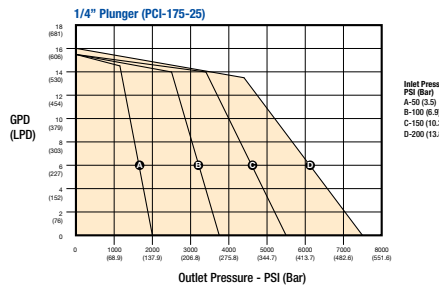

## 2" Air Motors (PCI-200)

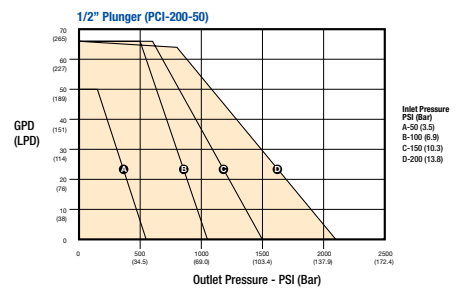
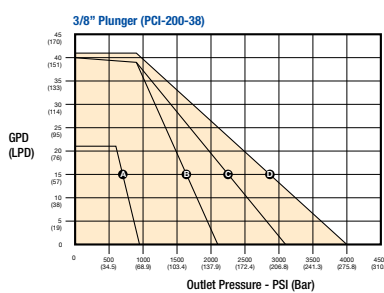
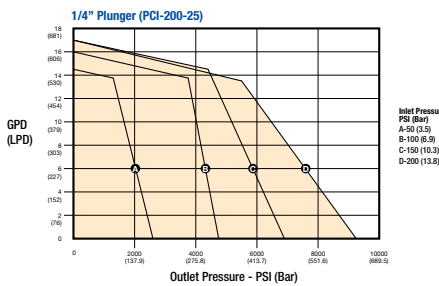

**Note:** please see instruction manual for different plunger sizes.



**MJ Systems, LLC**  
**Authorized Graco Distributors**  
 502 N 8th St • La Porte, TX 77571  
 Off (281) 842-7600 • Fax (281) 842-7601  
 www.mjsusa.com • sales@mjsusa.com

All written and visual data contained in this document are based on the latest product information available at the time of publication. Graco reserves the right to make changes at any time without notice.

